

**LAZAR**

Carlo Bimbi

**ARMAZEM** design



STARTING AT \$12,200

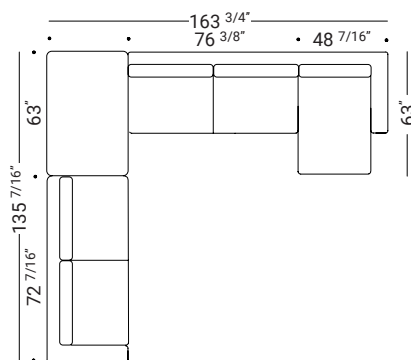

STARTING AT \$5,274

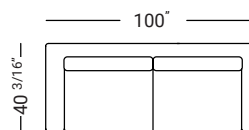

## PRODUCT CHARACTERISTICS

### FRAME

Wood coated with polyurethane and composite resin-bonded fine velvet

### SUSPENSION SYSTEM

Elastic belt springs coated with acrylic fibres

### MECHANISM

Adjust seat extension and back height at the same time

\*Fabric version is completely removable

\*Sofa bed not available.

\*Frame with chrome feet available.

## SECTION

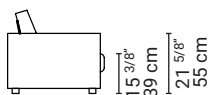

**2 SEAT SOFA**

☐ D20F0

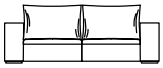
**WIDTH**72 7/16"  
184 cm**A & C.O.M.**

\$3,374

**B**

\$3,588

**C**

\$3,794

**D**

\$4,002

**E**

\$4,210

**F**

\$4,733

**P30\***

\$5,964

**P80**

\$6,557

☐ Chromed base +\$226

12.8 yds/11.7 lm

**2.5 SEAT SOFA**

☐ D25F0

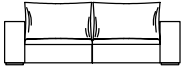
**WIDTH**80 5/16"  
204 cm**A & C.O.M.**

\$3,718

**B**

\$3,934

**C**

\$4,149

**D**

\$4,237

**E**

\$4,582

**F**

\$5,127

**P30\***

\$6,552

**P80**

\$7,209

☐ Chromed base +\$233

13.9 yds/12.7 lm

**3 SEAT SOFA**

☐ D30F0

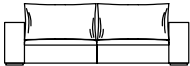
**WIDTH**92 1/8"  
234 cm**A & C.O.M.**

\$4,120

**B**

\$4,359

**C**

\$4,595

**D**

\$4,580

**E**

\$5,077

**F**

\$5,668

**P30\***

\$7,344

**P80**

\$8,077

☐ Chromed base +\$259

15 yds/13.75 lm

**3 SEAT SOFA MAXI**

☐ D3MF0

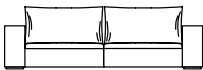
**WIDTH**100"  
254 cm**A & C.O.M.**

\$4,548

**B**

\$4,780

**C**

\$5,018

**D**

\$5,253

**E**

\$5,493

**F**

\$6,082

**P30\***

\$8,805

**P80**

\$9,685

☐ Chromed base +\$273

15 yds/13.75 lm

**2 SEAT TERMINAL ELEMENT DX/SX**

☐ LEFT - B20FS ☐ RIGHT - B20FD

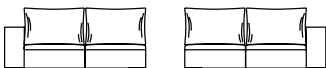
**WIDTH**64 9/16"  
164 cm**A & C.O.M.**

\$3,133

**B**

\$3,429

**C**

\$3,520

**D**

\$3,717

**E**

\$3,912

**F**

\$4,398

**P30\***

\$5,502

**P80**

\$6,053

☐ Chromed base +\$209

11.6 yds/10.65 lm

**2.5 SEAT TERMINAL ELEMENT DX/SX**

☐ LEFT - B25FS ☐ RIGHT - B25FD

**WIDTH**72 7/16"  
184 cm**A & C.O.M.**

\$3,527

**B**

\$3,724

**C**

\$3,934

**D**

\$4,132

**E**

\$4,325

**F**

\$4,839

**P30\***

\$6,138

**P80**

\$6,753

☐ Chromed base +\$227

12.7 yds/11.65 lm

**3 SEAT TERMINAL ELEMENT DX/SX**

☐ LEFT - B30FS ☐ RIGHT - B30FD

**WIDTH**84 1/4"  
214 cm**A & C.O.M.**

\$3,943

**B**

\$4,168

**C**

\$4,387

**D**

\$4,613

**E**

\$4,839

**F**

\$5,394

**P30\***

\$6,937

**P80**

\$7,634

☐ Chromed base +\$234

13.9 yds/12.75 lm

**3 SEAT TERMINAL ELEMENT MAXI DX/SX**

☐ LEFT - B3MFS ☐ RIGHT - B3MFD

**WIDTH**92 1/8"  
234 cm**A & C.O.M.**

\$4,367

**B**

\$4,582

**C**

\$4,810

**D**

\$5,038

**E**

\$5,253

**F**

\$5,814

**P30\***

\$8,411

**P80**

\$9,255

☐ Chromed base +\$258

13.9 yds/12.75 lm

**2 SEAT UNIT**

☐ C20F0

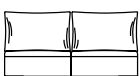
**WIDTH**56 11/16"  
144 cm**A & C.O.M.**

\$2,898

**B**

\$3,077

**C**

\$3,255

**D**

\$3,429

**E**

\$3,608

**F**

\$4,040

**P30\***

\$5,152

**P80**

\$5,669

☐ Chromed base +\$205

10.5 yds/9.6 lm

**2.5 SEAT UNIT**

☐ C25F0

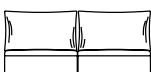
**WIDTH**64 9/16"  
164 cm**A & C.O.M.**

\$3,353

**B**

\$3,548

**C**

\$3,735

**D**

\$3,934

**E**

\$4,120

**F**

\$4,613

**P30\***

\$5,753

**P80**

\$6,328

☐ Chromed base +\$209

11.6 yds/10.65 lm

**3 SEAT UNIT**

C30F0

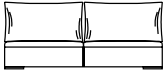

**WIDTH**

76 3/8"  
194 cm

**A & C.O.M.**

\$3,785

**B**

\$3,994

**C**

\$4,199

**D**

\$4,407

**E**

\$4,613

**F**

\$5,127

**P30\***

\$6,562

**P80**

\$7,219

Chromed base +\$227

12.8 yds/11.7 lm

**PENINSULA DX/SX**

LEFT - M01FS  RIGHT - M01FD

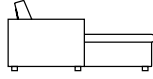
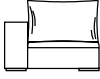

**WIDTH**

48 1/16"  
122 cm

**A & C.O.M.**

\$2,534

**B**

\$2,671

**C**

\$2,808

**D**

\$2,948

**E**

\$3,095

**F**

\$3,439

**P30\***

\$4,704

**P80**

\$5,174

Chromed base +\$377

8.75 yds/8 lm

**SQUARE CORNER 100x100**

A01F0

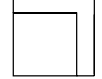
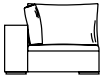

**WIDTH**

39 3/8"  
100 cm

**A & C.O.M.**

\$2,228

**B**

\$2,355

**C**

\$2,490

**D**

\$2,602

**E**

\$2,760

**F**

\$3,095

**P30\***

\$4,113

**P80**

\$4,520

Chromed base +\$192

8.2 yds/7.5 lm

**POUF 80x100**

P08F0



**WIDTH**

31 1/2"  
80 cm

**A & C.O.M.**

\$1,095

**B**

\$1,153

**C**

\$1,213

**D**

\$1,274

**E**

\$1,342

**F**

\$1,488

**P30\***

\$1,898

**P80**

\$2,088

Chromed base +\$192

3.8 yds/3.5 lm

**POUF 100x100**

P02F0

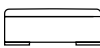

**WIDTH**

39 3/8"  
100 cm

**A & C.O.M.**

\$1,283

**B**

\$1,359

**C**

\$1,439

**D**

\$1,518

**E**

\$1,597

**F**

\$1,797

**P30\***

\$2,185

**P80**

\$2,407

Chromed base +\$192

3.8 yds/3.5 lm

**POUF 160x100**

P01F0

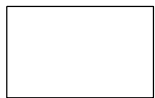

**WIDTH**

63"  
160 cm

**A & C.O.M.**

\$1,697

**B**

\$1,811

**C**

\$1,920

**D**

\$2,032

**E**

\$2,147

**F**

\$2,425

**P30\***

\$2,965

**P80**

\$3,264

Chromed base +\$192

5.6 yds/5.1 lm

**CUSHION WITH SUPPORTING STRUCTURE**

C5050

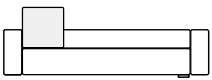

**WIDTH**

20 1/2"  
52 cm

**A & C.O.M.**

\$297

**B**

\$333

**C**

\$367

**D**

\$407

**E**

\$444

**F**

\$520

**P30\***

\$629

**P80**

\$695

1.6 yds/1.45 lm

\*\*FABRIC SELECTION: \_\_\_\_\_

Cushion cover: \_\_\_\_\_

Frame cover: \_\_\_\_\_

**METAL FRAME**

Mocha L019

Chrome base G093

**USE & CARE:** Indoor use only. Avoid exposure to direct sun. Avoid direct contact with water. Clean with damp cloth. Do not use wax. Dust with flannel cloth. Avoid dragging and lift with care. Do not stand on.

\*\*HIGHER FABRIC CATEGORY APPLIES IF A COMBINATION IS CHOSEN.

\*ONLY AVAILABLE IN NOVABUK.