

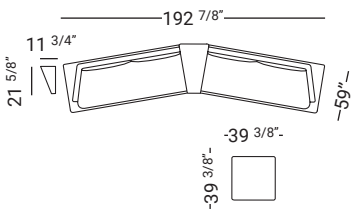

STARTING AT \$9,299

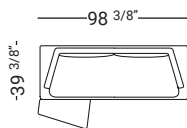

STARTING AT \$5,963



STARTING AT \$8,530

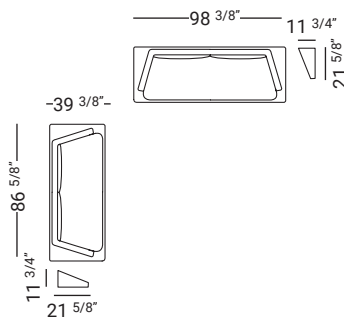

STARTING AT \$7,805

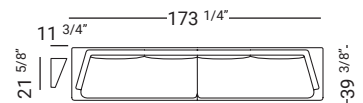

PRODUCT CHARACTERISTICS

SUPPORTING STRUCTURE
Solid and multilayer wood

BACK CUSHION PADDING
100% goose down divided into sections

SUSPENSION SYSTEM
Interlaced elastic belts on a metal frame

SEAT CUSHION PADDING
High density polyurethane foam covered in fibre

PADDING
Polyurethane foam of different densities with self-binding fibre

*Fabric version is completely removable

*Leather version has removable cushion covers only

*Sofa is equipped with mechanism for tilting headrest with cushion 55x40 cm included

SECTION

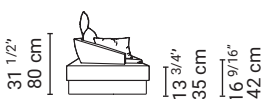

3 SEAT SOFA

☐ D30F0

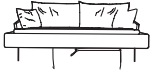

WIDTH
86 5/8"
220 cm

A & C.O.M.
\$3,894

B
\$4,062

C
\$4,249

D
\$4,428

E
\$4,607

F
\$5,059

P30*
\$6,009

P80
\$7,245

13.1 yds/12 lm

3 SEAT SOFA MAXI

☐ D3MF0



WIDTH
98 3/8"
250 cm

A & C.O.M.
\$4,279

B
\$4,469

C
\$4,657

D
\$4,847

E
\$5,050

F
\$5,534

P30*
\$6,372

P80
\$7,682

14.2 yds/13 lm

1.5 SEAT TERMINAL

☐ LEFT - B15FS ☐ RIGHT - B15FD



WIDTH
43 1/4"
110 cm

A & C.O.M.
\$2,439

B
\$2,534

C
\$2,645

D
\$2,729

E
\$2,842

F
\$3,084

P30*
\$3,593

P80
\$4,308

7.1 yds/6.5 lm

3 SEAT TERMINAL

☐ LEFT - B30FS ☐ RIGHT - B30FD



WIDTH
74 3/4"
190 cm

A & C.O.M.
\$3,740

B
\$3,903

C
\$4,059

D
\$4,222

E
\$4,392

F
\$4,803

P30*
\$5,618

P80
\$6,692

11.3 yds/10.3 lm

3 SEAT TERMINAL MAXI DX/SX

☐ LEFT - B3MFS ☐ RIGHT - B3MFD



WIDTH
86 5/8"
220 cm

A & C.O.M.
\$4,180

B
\$4,355

C
\$4,557

D
\$4,732

E
\$4,944

F
\$5,392

P30*
\$6,308

P80
\$7,514

12.5 yds/11.4 lm

PENINSULA DX/SX

☐ LEFT - M01FS ☐ RIGHT - M01FD



WIDTH
43 1/4"
110 cm

A & C.O.M.
\$3,779

B
\$3,937

C
\$4,084

D
\$5,091

E
\$4,400

F
\$4,785

P30*
\$5,578

P80
\$6,557

9.6 yds/8.8 lm

OPTIONAL PULL-OUT HEADREST

☐ P02F0



WIDTH
12 1/4"
31 cm

A & C.O.M.
\$469

B
\$487

C
\$500

D
\$519

E
\$530

F
\$670

P30*
\$662

P80
\$684

1 yd/0.9 lm

POUF

☐ P02F0



WIDTH
39 3/8"
100 cm

A & C.O.M.
\$1,652

B
\$1,685

C
\$1,732

D
\$1,777

E
\$1,810

F
\$1,924

P30*
\$1,093

P80
\$2,247

1.9 yd/1.7 lm

TRIANGULAR OTTOMAN

☐ P08F0

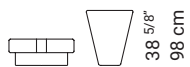

WIDTH
26"
66 cm

A & C.O.M.
\$1,448

B
\$1,494

C
\$1,528

D
\$1,573

E
\$1,607

F
\$1,720

P30*
\$1,788

P80
\$2,104

1.9 yd/1.7 lm

**FABRIC SELECTION: _____

Cushion cover: _____

Frame cover: _____

METAL FRAME

Chrome base G093

USE & CARE: Indoor use only. Avoid exposure to direct sun. Avoid direct contact with water. Clean with damp cloth. Do not use wax.
Dust with flannel cloth. Avoid dragging and lift with care. Do not stand on.

**HIGHER FABRIC CATEGORY APPLIES IF A COMBINATION IS CHOSEN.

*ONLY AVAILABLE IN NOVABUK.